

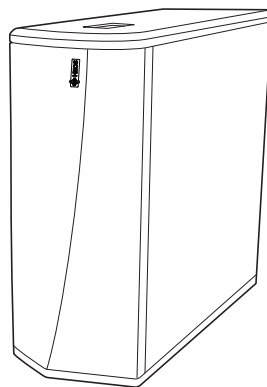

# Owner's Manual

## HEOS Subwoofer



<b>Introduction</b>	<b>4</b>	<b>Making adjustments</b>	<b>21</b>
<b>Before your begin</b>	<b>5</b>	Adjusting the Level	21
System requirements	5	Adjusting the Low Pass Filter	21
Network requirements	5	Adjusting the Phase	22
Hardware Requirements	6	Adjusting the status light brightness	22
Controller requirements	7		
Getting to know your HEOS Subwoofer	8		
Front panel	10		
Controls	11		
Back panel	12		
<b>Placing your HEOS Subwoofer</b>	<b>13</b>		
Powering your HEOS Subwoofer	14		
Getting the HEOS app	15		
<b>Setting up your first HEOS Subwoofer</b>	<b>16</b>		
<b>Adding more HEOS devices</b>	<b>17</b>		
Adding wired HEOS devices	17		
Adding wireless HEOS devices	17		
<b>Connecting devices</b>	<b>18</b>		
Pairing a HEOS Subwoofer to a HEOS device	18		
Pairing HEOS subwoofer to HEOS AVR or HEOS Bar	18		
Pairing HEOS Subwoofer to other HEOS device	19		
Unpairing the HEOS Subwoofer	20		

<b>Updating your system</b>	<b>23</b>	<b>Specifications</b>	<b>37</b>
<b>Advanced features</b>	<b>24</b>	<b>Information</b>	<b>39</b>
Wireless performance	24	Trademarks	39
<b>Power management</b>	<b>25</b>	License	40
Power modes	25	License information for the software used in the unit	40
Quick Start Mode	25		
Deep Standby	25		
Off	25		
<b>Basic troubleshooting</b>	<b>26</b>		
My HEOS device won't connect to my network using the audio cable	26		
My HEOS device turns off and the status LED flashes in red	26		
Connecting to a WPS network	27		
Resetting your HEOS device	27		
Restoring the HEOS device to factory defaults	28		
Contact Denon	29		
<b>Status LED table</b>	<b>30</b>		
<b>Supported file types and codecs</b>	<b>36</b>		



Thank you for purchasing this HEOS product. To ensure proper operation, please read this owner's manual carefully before using the product.

#### NOTE

- THIS DOCUMENT CONTAINS INFORMATION THAT IS SUBJECT TO CHANGE WITHOUT NOTICE.

For latest information, please visit <http://www.HEOSbyDenon.com>

## Introduction

The HEOS Subwoofer is part of the HEOS wireless multi-room sound system that enables you to enjoy your favorite music anywhere and everywhere around your home. By utilizing your existing home network and the HEOS app on your iOS or Android™ device, you can explore, browse, and play music from your own music library or from many online streaming music services.

- True multi-room audio - play different songs in different rooms or the same song in every room
- Utilizes your existing home wireless network for quick and easy setup
- Industry leading microsecond audio synchronization between HEOS device
- Legendary Denon audio quality
- If you are in a hurry, you can be enjoying great sounding music in no time by following the steps outlined in the HEOS Quick Start Guide (packaged with your HEOS device).



Please continue reading this Owner's Manual for more detailed information about the features and benefits of your HEOS Subwoofer.

# Before your begin

---

## NOTE

- If you have already installed at least one HEOS device, please skip to the section "Adding more HEOS devices" ( p. 17).

## System requirements

Before you begin installing your first HEOS device, please make sure you understand and meet a few basic requirements.

### ■ Network requirements

**Wireless Router** - In order to use your HEOS music system, you must have a working wireless (Wi-Fi) or ethernet network in your home. Even when connected to an Ethernet network, a Wi-Fi connection to the router is required to control the system using the HEOS Control app. If you do not have a wireless network, please contact your local Denon dealer or electronics retailer to assist you with purchasing and installing a wireless network in your home.

**High Speed Internet Connection** - HEOS accesses the Internet to stream music to your home from many popular online music services. HEOS is also designed to provide you with software updates, which are delivered via your home Internet connection. DSL, Cable, and Fiber services will provide the best experience and reliability. You may experience performance issues with slower Internet connections like satellite based services.

## ■ Hardware Requirements

Use the HEOS Subwoofer together with existing HEOS devices.

[Example]

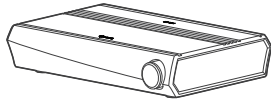

HEOS AVR

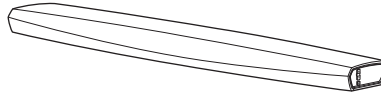

HEOS Bar

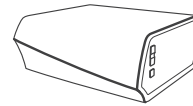

HEOS Amp

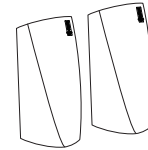

HEOS speaker

### NOTE

- HEOS Subwoofer can not be used by itself.

## ■ Controller requirements

You can control your HEOS wireless multi-room sound system using the free HEOS app on any iOS or Android mobile device that meets these minimum requirements:



### iOS Minimum Requirements

- iOS version 7.0 or later
- iPhone® 4 or newer
- iPad® 2 or newer
- iPod touch® (5th generation) or newer



### Android Minimum Requirements

- Android OS version 4.0 or later
- All resolutions

## Getting to know your HEOS Subwoofer

Unpack your HEOS Subwoofer from the box and verify that the following items are included:

HEOS Subwoofer

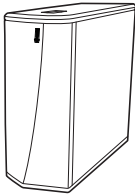

Quick Start Guide

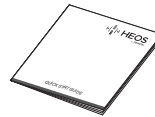

Thank you note  
(North America model only)



Extended Protection Plan  
(North America model only)



Warranty  
(North America model only)

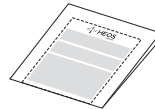

Safety instructions





Power cord

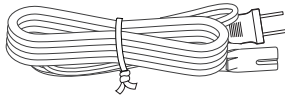

1/8 inch (3.5 mm) setup cable



Ethernet cable

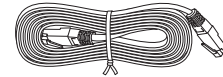

Feet



**NOTE**

- Please use the power cord included in the box for your device.

## ■ Front panel



### 1 Status LED

Please refer to the “Status LED table” for LED color and state meaning. (☞ p. 30)

## ■ Controls

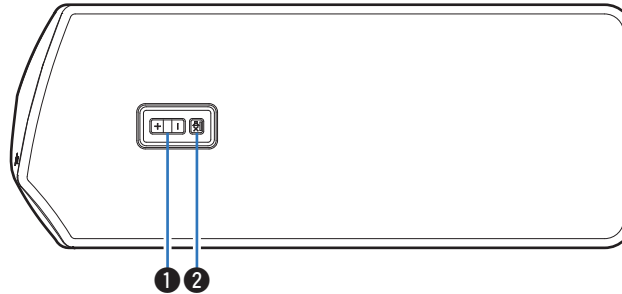

**1 Volume up/down buttons (+, -)**

Adjusts the HEOS device's volume level up or down.

**2 Mute button (🔇)**

Mutes or unmutes the HEOS device's volume.

## ■ Back panel

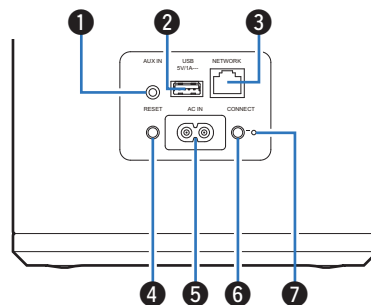

### ❶ AUX jack (AUX IN)

Used to add the HEOS device to your wireless network.  
([👉 p. 16](#))

### ❷ USB port

Used to connect USB storage devices.

### ❸ NETWORK connector

Used to connect this unit to a wired Ethernet network. ([👉 p. 16](#))

### ❹ RESET button

Various settings are reset to the factory default values.  
([👉 p. 27](#))

### ❺ AC inlet (AC IN)

Used to connect the power cord. ([👉 p. 14](#))

### ❻ CONNECT button

Used for Wi-Fi setup.

### ❼ Connect in status LED

Indicates the status of this unit. ([👉 p. 30](#))

## Placing your HEOS Subwoofer

The HEOS Subwoofer is designed to add HEOS multi-room audio functionality to an external device which offers audio amplification. You should place your HEOS Subwoofer in a convenient location near the speakers you are connecting it to.

- The HEOS Subwoofer must be within range of your wireless network.

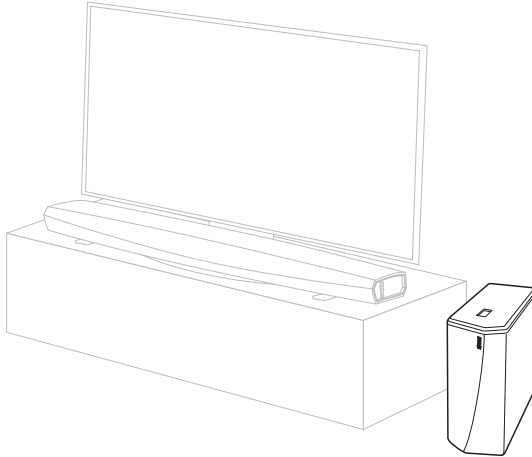

- Attach the included feet to the four corners of the HEOS Subwoofer's side if you are placing it on horizontally.

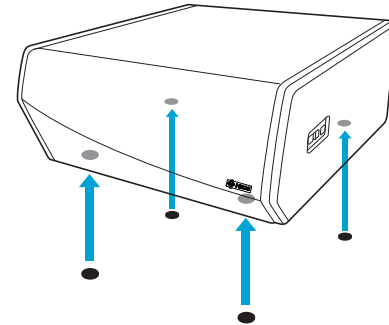

## Powering your HEOS Subwoofer

Connect the power cord included in the box to the back of the HEOS Subwoofer and the plug to a wall outlet.

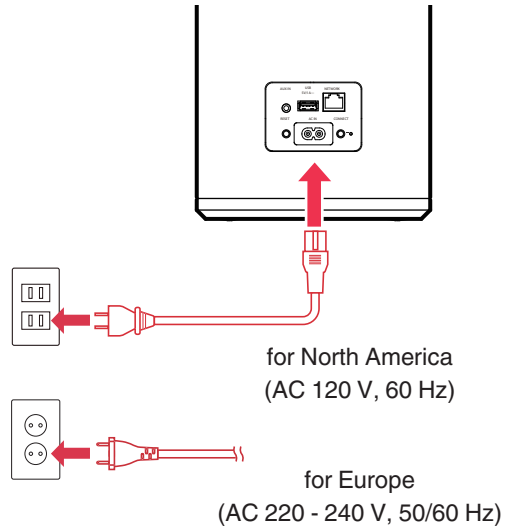

## Getting the HEOS app

The HEOS app is the heart of the HEOS experience. Using your mobile device and the HEOS app, you can setup, browse, explore, and control your HEOS system right in the palm of your hand, from anywhere in your home.

Download the HEOS app for iOS or Android by searching App Store®, Google Play™ store or Amazon for “HEOS”.



For the purpose of improvement, the specifications and design are subject to change without notice.

# Setting up your first HEOS Subwoofer

Once you have placed your HEOS Subwoofer in your listening room and have downloaded the HEOS app, you are ready to configure your HEOS Subwoofer for music playback. This involves following a few simple steps to get the HEOS Subwoofer connected to your existing home network:

## Caution

- DO NOT connect the Ethernet cable if you are connecting your HEOS Subwoofer to a wireless network. If you are connecting the HEOS Subwoofer to a wired network, use an Ethernet cable to connect the HEOS Subwoofer to your network or router.

## 1 Make sure your mobile device is connected to your wireless network (the same network you want your HEOS Subwoofer connected to).

You can check this in the Settings - Wi-Fi menu of your iOS or Android device.

## NOTE

- If your wireless network is secure, make sure you know the password to join your network.

## 2 Make sure you have the included 1/8 inch (3.5 mm) setup cable handy.

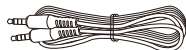

## 3 Launch the HEOS app on your mobile device.



## 4 Tap the “Setup Now” button at the top of the screen.

## 5 Follow the instructions to add the HEOS Subwoofer to your wireless network.

The Wi-Fi settings from your mobile device will be copied to the HEOS Subwoofer via the audio cable.

## NOTE

- If you have any problems connecting your HEOS device, jump to the Troubleshooting section. (🔍 p. 26)



## Adding more HEOS devices

The HEOS wireless multi-room sound system is a true multiroom audio system that automatically synchronizes audio playback between multiple HEOS devices so that the audio coming from different rooms is perfectly in sync and always sounds amazing! You can easily add up to 32 devices to your HEOS system.

### Adding wired HEOS devices

Just connect the HEOS devices to your home network using an Ethernet cable and the HEOS devices will appear on your HEOS app as a new room in the “Rooms” screen.

At your convenience, you can assign a name to the HEOS devices to indicate which room you have it placed in.



- Use only a shielded STP or ScTP LAN cable which is easily available at electronics stores (CAT-5 or greater recommended).
- Do not connect a Network Connector directly to the LAN port/Ethernet connector on your computer.

### Adding wireless HEOS devices

You can add additional wireless HEOS devices to your HEOS system by selecting “Add Device” from the HEOS app’s settings menu and follow the instructions:

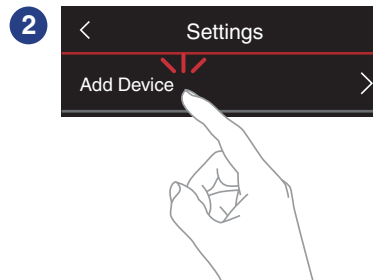
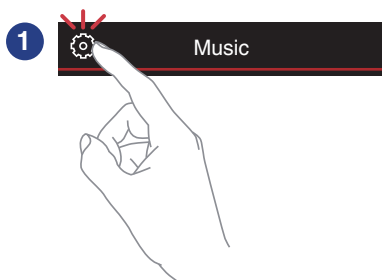

## Connecting devices

### Pairing a HEOS Subwoofer to a HEOS device

The HEOS Subwoofer needs to be paired with another HEOS device.

#### ■ Pairing HEOS subwoofer to HEOS AVR or HEOS Bar

- 1** Select the **Settings**  icon located in the upper left corner of the main “Music” menu to display the **Settings** menu.
- 2** Select the **HEOS AVR** or **HEOS Bar** from “My Devices”.
- 3** Select **Setup Assistant** and add the **HEOS Subwoofer**.  
Follow the instructions in the menu to complete the setup.

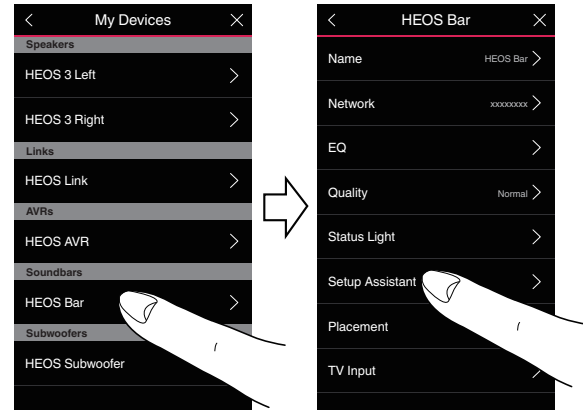

#### NOTE

- A HEOS Subwoofer can not playback any audio unless it is paired with some other HEOS device.
- A HEOS Subwoofer needs to connect your wireless network before pairing.

## ■ Pairing HEOS Subwoofer to other HEOS device

**1** Select the currently unpaired HEOS Subwoofer.

**2** Select the HEOS device to be paired.

The HEOS Subwoofer will be grouped together with it and will play the deep bass of the added HEOS device.



The following HEOS devices can be connected like this

- HEOS Amp
- HEOS Link
- HEOS speaker

### NOTE

- A HEOS Subwoofer can not playback any audio unless it is paired with some other HEOS device.
- A HEOS Subwoofer needs to connect your wireless network before pairing.

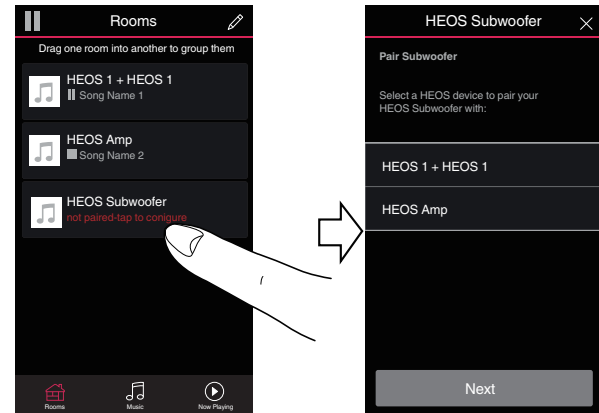

## Unpairing the HEOS Subwoofer

- 1 Tap the pencil  icon in the upper right corner of the "Rooms" menu.
- 2 Tap the HEOS device from which to unpair the HEOS Subwoofer.
- 3 Select "Disconnect Wireless Subwoofers".

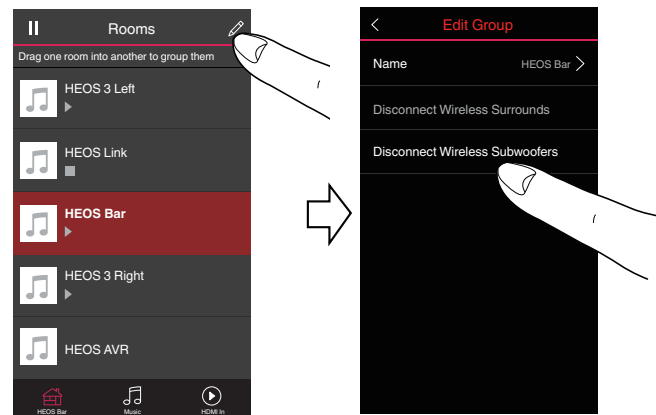

## Making adjustments

You can adjust specific settings for each of your HEOS device in your system:

- 1 Select the **Settings**  icon located in the upper left corner of the main “Music” menu to display the Settings menu.
- 2 Select “My Devices” to display a list of your HEOS devices.
- 3 Select the HEOS device you want to adjust.

### Adjusting the Level

- 1 Select “Level”.
- 2 Adjust the level up or down to compensate for the subwoofer output level.



- You can also configure settings by tapping  in the Now Playing screen.

### Adjusting the Low Pass Filter

- 1 Select “Low Pass Filter”.
- 2 Set the frequency cutoff point.

Optimized (recommended)	Select when using with HEOS speakers. Optimized values are set to each of the speakers.
40Hz - 250Hz (for experts)	When using with other speakers, configure settings that match the characteristics of the combined speakers.

## Adjusting the Phase

- 1 Select “Phase”.
- 2 Select Normal (default) or 180°.



- For normal configuration, use “Normal”.
- The bass volume may increase when switched to “180°” due to the installation location of the Subwoofer.

## Adjusting the status light brightness

- 1 Select “Status Light”.
- 2 Adjust the brightness up or down or set the slider to the OFF position to completely disable the status light.

## Updating your system

---

HEOS has the ability to add enhancements and updated functionality via your high speed Internet connection. Follow the instructions on the screen to update the HEOS device and/or your controller App.

- 1** Select the **Settings**  icon located in the upper left corner of the main “Music” menu to display the **Settings** menu.

- 2** Select “**Software Update**”.

### **Check for Update**

---

Follow the instructions on screen to install any available updates to your HEOS system.

---

### **Auto-Update**

---

**ON:** Valid updates are performed automatically.

---

**OFF:** You will be notified of valid updates on the HEOS app.

---

## Advanced features

There are a few advanced features of the HEOS system that you may want to explore once you become familiar with the basic operations. You can access the advanced features of the HEOS system by following these steps:

- 1** Select the **Settings**  icon located in the upper left corner of the main “Music” menu to display the **Settings** menu.
- 2** Select “**Advanced Settings**” to display a list the available settings.

### Wireless performance

You can check the wireless connection status of your HEOS device.

#### Quality

---

Excellent / Good / Poor

---

#### NOTE

- If the quality level of your HEOS device is “Poor”, make sure your HEOS devices are not located near other electronic devices that could interfere with it’s wireless connectivity (like microwave ovens, cordless phones, TVs, etc...)

#### Signal

---

Excellent / Good / Poor

---

#### NOTE

- If the signal level of your HEOS device is “Poor”, make sure your HEOS devices are within range of your wireless network.



# Power management

## Power modes

### ■ Quick Start Mode

To save power, the device will automatically enter “Quick Start Mode” whenever there is no network access or playback for 20 minutes and will automatically resume to full power whenever the device is selected and playing music.

The status LED dims when the mode is switched to Quick Start Mode.

### ■ Deep Standby

The device also has the ability to automatically enter “Deep Standby” whenever the wired and wireless network connections are removed for more than 60 minutes in Quick Start Mode. Status LED will turn off during Deep Standby.

To “wake” a HEOS device from Deep Standby, you must press the volume or mute buttons which will immediately turn on the front panel LED.

#### NOTE

- Please note that the HEOS cannot be operated as intended when in Deep Standby as there is no network connection.

### ■ Off

To completely turn off the power to the device you must remove the mains plug from the power outlet.

## Basic troubleshooting

### My HEOS device won't connect to my network using the audio cable

Solution	Refer to Page
<ul style="list-style-type: none"><li>• Make sure your mobile device is connected to your wireless network before setting up your device.</li></ul>	<u>16</u>
<ul style="list-style-type: none"><li>• Alternatively, you can connect your device to your network router using the included Ethernet cable. Once connected via Ethernet, the HEOS App should recognize the device and you can manually move it to your wireless network using Settings/My Devices/Device_Name/Advanced/Network Settings.</li></ul>	<u>17</u>

### My HEOS device turns off and the status LED flashes in red

Solution	Refer to Page
<ul style="list-style-type: none"><li>• The protection circuit has been activated due to a rise in temperature within your HEOS device. Turn the power off, wait about an hour until this device cools down sufficiently, and then turn the power on again.</li></ul>	–

## Connecting to a WPS network

Solution	Refer to Page
<ul style="list-style-type: none"> <li>If your wireless router support WPS (Wi-Fi Protected Setup™) your HEOS wireless device can optionally connect to your network using the “Push Button” method by following these steps: Wi-Fi Protected Setup™ is trademarks of Wi-Fi Alliance.</li> </ul> <ol style="list-style-type: none"> <li>Press the WPS button on your router.</li> <li>Within 2 minutes, press and hold the Connect button on the rear panel of the HEOS device for 3 seconds.</li> <li>The LED on the front of the device will flash green for several seconds as it connects to your WPS router.</li> <li>When the connection is complete, the LED on the front of the device will turn solid blue.</li> </ol>	5

## Resetting your HEOS device

Solution	Refer to Page
<ul style="list-style-type: none"> <li>Resetting your HEOS device will clear out the wireless network info, EQ, and name but retain it's current software. You will have to use Settings - Add Device to reconnect the HEOS device to your home network before it can be used. To reset your HEOS device, press and hold the RESET buttons located on the back of the HEOS device for 5 seconds until the front LED begins to flash amber.</li> </ul>	-

## Restoring the HEOS device to factory defaults

Solution	Refer to Page
<ul style="list-style-type: none"><li>Restoring the HEOS device to its factory defaults will clear all of the settings and restore the original software which was installed at the factory.</li></ul> <p><b>Caution</b></p> <ul style="list-style-type: none"><li>All settings will be erased and the software will likely be downgraded!</li></ul> <p>To restore your HEOS device to the factory defaults, unplug the power cable from the power outlet. Press and hold the RESET button located on the back of the HEOS device, reconnect the power cable, and hold it in until the front LED begins to flash amber.</p>	-

\* For further information, please visit <http://www.HEOSbyDenon.com>

## Contact Denon

**For U.S. & Canada only:**

If you need further assistance with your HEOS product, please contact HEOS Customer Support Services below:

Website: [www.HEOSbyDenon.com/Support](http://www.HEOSbyDenon.com/Support)

Email: [Support@HEOSbyDenon.com](mailto:Support@HEOSbyDenon.com)

Live Chat: [www.HEOSbyDenon.com/LiveChat](http://www.HEOSbyDenon.com/LiveChat)

Telephone: Toll Free (855) 499 2820











(M-F 10:00AM to 10:00PM EST / Sat 12:00PM to 8:00PM EST)









**For the other region:**











If you need additional help in solving problems, please contact Denon customer service in your area or visit <http://www.HEOSbyDenon.com>











## Status LED table







Device Operation	Description	Front LED Action	Rear LED Action
Off	No AC power or Deep Standby	 (off)	 (off)
Plug in	Booting	 (blink)	 (off)
On	Ready-Configured and connected to your network	 (solid)	 (off)
On	Not Connected to your network	 (solid)	 (solid)
Change Network	Connecting to your network	 (blink)	 (off)











Device Operation	Description	Front LED Action	Rear LED Action
Setup	Not connected	 (solid)	 (solid)
	Connect button was pressed	 (blink)	 (blink)
	Cable connection is OK	 (solid)	 (solid)
	Connecting to your network	 (blink)	 (off)

Device Operation	Description	Front LED Action	Rear LED Action
Setup	Configured and connected to your network	 (solid)	 (off)
	Error	 (solid)	 (solid)
Update	Updating	 (blink)	 (blink)
	Rebooting	 (blink)	 (off)
	Ready-Configured and connected to your network	 (solid)	 (off)



Device Operation	Description	Front LED Action	Rear LED Action
Reset	Soft reset - Clear user settings	 <p>(fast blink)</p>	 <p>(solid)</p>
	Hard reset - Factory restore	 <p>(blink)</p>	 <p>(solid)</p>
	Rebooting	 <p>(blink)</p>	 <p>(off)</p>
	Ready-Not Configured	 <p>(solid)</p>	 <p>(solid)</p>

Device Operation	Description	Front LED Action	Rear LED Action
Errors	Firmware Error	 (slow blink (NOT fade))	 (off)
	Hardware Error	 (fast blink)	 (off)
	Network Error	 (solid)	 (solid)

Device Operation	Description	Front LED Action	Rear LED Action
WPS	a WPS session is active	 (fast blink)	 (fast blink)
	WPS connected	 (for 3 sec. solid)	 (solid)
	WPS time-out	 (for 3 sec. solid)	 (solid)
Power Management	Quick Start Mode	 (dimmed solid)	 (off)
	Deep Standby	 (off)	 (off)

## Supported file types and codecs

Frequency	Sample Rate	File Extension	Codec	Bit Rates
32/44.1/48 88.2/96/176.4 192 kHz	16/24 bit	wav	PCM	---
32 kHz 44.1 kHz 48 kHz	16 bit	mp3	MPEG-1 Audio Layer 3 CBR/VBR	32 - 320 kbps
32 kHz 44.1 kHz 48 kHz	16 bit	m4a aac	AAC-LC	48 - 320 kbps
32 kHz 44.1 kHz 48 kHz	16 bit	wma	wma9 CBR	CBR:48 - 192 kbps
44.1/48 88.2/96/176.4 192 kHz	16/24 bit	flac	flac	---
44.1/48 88.2/96/176.4 192 kHz	16/24 bit	m4a	ALAC	---
2.8/5.6 MHz	1 bit	dff dsf	DSDIFF DSF	---

### NOTE

- Files protected by DRM such as Apple's Fairplay DRM, are not supported.
- The ALAC decoder is distributed under the Apache License, Version 2.0 (<http://www.apache.org/licenses/LICENSE-2.0>)



# Specifications

---

## ■ Wireless LAN section

Network type:	Conforming to IEEE 802.11a/b/g/n/ac
Used frequency range:	2.4 GHz, 5 GHz

## ■ General

Operating temperature:	41 °F - 95 °F (5 °C - 35 °C)
Power supply:	AC 100 - 240 V, 50/60 Hz
Power consumption:	70 W
Power consumption in Quick Start Mode:	4.5 W
Power consumption in Deep Standby Mode:	0.3 W

## ■ Dimensions (Unit : in. (mm))

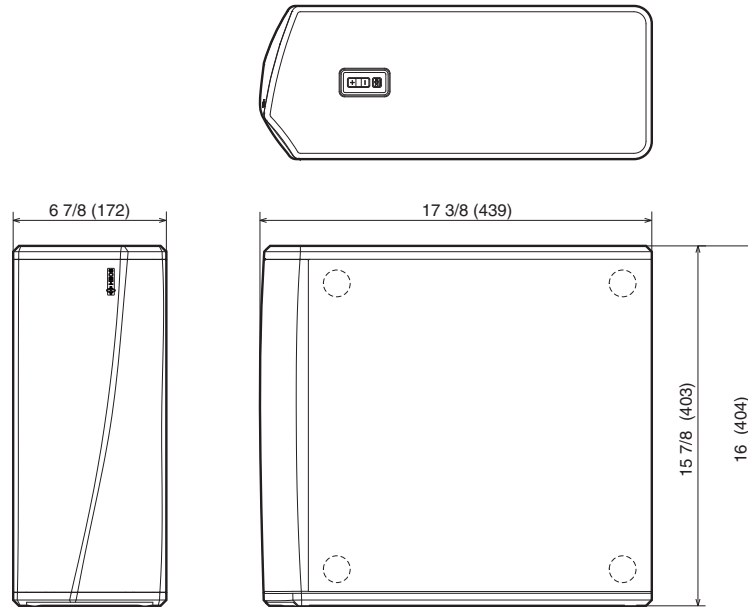

## ■ Weight : 22 lbs 4 oz (10.1 kg)

For the purpose of improvement, the specifications and design are subject to change without notice.

# Information

## Trademarks



Google Play is a trademark of Google Inc.



Apple, the Apple logo, iPad, iPhone, and iPod touch are trademarks of Apple Inc., registered in the U.S. and other countries. App Store is a service mark of Apple Inc.



Amazon, Kindle, Echo, Alexa, Dash, Fire and all related logos are trademarks of Amazon.com, Inc. or its affiliates.

## License

### ■ License information for the software used in the unit

#### About GPL (GNU-General Public License), LGPL (GNU Lesser General Public License) License

This product uses GPL/LGPL software and software made by other companies.

After you purchase this product, you may procure, modify or distribute the source code of the GPL/LGPL software that is used in the product.

Denon provides the source code based on the GPL and LGPL licenses at the actual cost upon your request to our customer service center. However, note that we make no guarantees concerning the source code. Please also understand that we do not offer support for the contents of the source code.

This section describes software license used for this unit. To maintain the correct content, the original (English) is used.

### □ GPL

Open Source Used	Version
bridge-utils	2.8
busybox	1.21.1
eatables	2.0.10-4
Linux kernel	3.10.74
mtd-utils	1.4.3
ntfs-3g_ntfsprogs	2011.4.12
ntpclient	2007
u-boot	2015.01
wireless-tools	version 29

### □ LGPL

Open Source Used	Version
ffmpeg	0.8.3
glibc	2.9
libmms	0.6.2

### □ curl-7.24.0

#### COPYRIGHT AND PERMISSION NOTICE

Copyright (c) 1996 - 2014, Daniel Stenberg, <[daniel@haxx.se](mailto:daniel@haxx.se)>

All rights reserved.

Permission to use, copy, modify, and distribute this software for any purpose with or without fee is hereby granted, provided that the above copyright notice and this permission notice appear in all copies.

THE SOFTWARE IS PROVIDED "AS IS", WITHOUT WARRANTY OF ANY KIND, EXPRESS OR IMPLIED, INCLUDING BUT NOT LIMITED TO THE WARRANTIES OF MERCHANTABILITY, FITNESS FOR A PARTICULAR PURPOSE AND NONINFRINGEMENT OF THIRD PARTY RIGHTS. IN NO EVENT SHALL THE AUTHORS OR COPYRIGHT HOLDERS BE LIABLE FOR ANY CLAIM, DAMAGES OR OTHER LIABILITY, WHETHER IN AN ACTION OF CONTRACT, TORT OR OTHERWISE, ARISING FROM, OUT OF OR IN CONNECTION WITH THE SOFTWARE OR THE USE OR OTHER DEALINGS IN THE SOFTWARE.

Except as contained in this notice, the name of a copyright holder shall not be used in advertising or otherwise to promote the sale, use or other dealings in this Software without prior written authorization of the copyright holder.





## ❑ e2fsprogs-libs-1.40.8/lib/uuid

Redistribution and use in source and binary forms, with or without modification, are permitted provided that the following conditions are met:

1. Redistributions of source code must retain the above copyright notice, and the entire permission notice in its entirety, including the disclaimer of warranties.
2. Redistributions in binary form must reproduce the above copyright notice, this list of conditions and the following disclaimer in the documentation and/or other materials provided with the distribution.
3. The name of the author may not be used to endorse or promote products derived from this software without specific prior written permission.

THIS SOFTWARE IS PROVIDED "AS IS" AND ANY EXPRESS OR IMPLIED WARRANTIES, INCLUDING, BUT NOT LIMITED TO, THE IMPLIED WARRANTIES OF MERCHANTABILITY AND FITNESS FOR A PARTICULAR PURPOSE, ALL OF WHICH ARE HEREBY DISCLAIMED. IN NO EVENT SHALL THE AUTHOR BE LIABLE FOR ANY DIRECT, INDIRECT, INCIDENTAL, SPECIAL, EXEMPLARY, OR CONSEQUENTIAL DAMAGES (INCLUDING, BUT NOT LIMITED TO, PROCUREMENT OF SUBSTITUTE GOODS OR SERVICES; LOSS OF USE, DATA, OR PROFITS; OR BUSINESS INTERRUPTION) HOWEVER CAUSED AND ON ANY THEORY OF LIABILITY, WHETHER IN CONTRACT, STRICT LIABILITY, OR TORT (INCLUDING NEGLIGENCE OR OTHERWISE) ARISING IN ANY WAY OUT OF THE USE OF THIS SOFTWARE, EVEN IF NOT ADVISED OF THE POSSIBILITY OF SUCH DAMAGE.

## ❑ expat-2.0.1

Copyright (c) 1998, 1999, 2000 Thai Open Source Software Center Ltd and Clark Cooper

Copyright (c) 2001, 2002, 2003, 2004, 2005, 2006 Expat maintainers.

Permission is hereby granted, free of charge, to any person obtaining a copy of this software and associated documentation files (the "Software"), to deal in the Software without restriction, including without limitation the rights to use, copy, modify, merge, publish, distribute, sublicense, and/or sell copies of the Software, and to permit persons to whom the Software is furnished to do so, subject to the following conditions:

The above copyright notice and this permission notice shall be included in all copies or substantial portions of the Software.

THE SOFTWARE IS PROVIDED "AS IS", WITHOUT WARRANTY OF ANY KIND, EXPRESS OR IMPLIED, INCLUDING BUT NOT LIMITED TO THE WARRANTIES OF MERCHANTABILITY, FITNESS FOR A PARTICULAR PURPOSE AND NONINFRINGEMENT.

IN NO EVENT SHALL THE AUTHORS OR COPYRIGHT HOLDERS BE LIABLE FOR ANY CLAIM, DAMAGES OR OTHER LIABILITY, WHETHER IN AN ACTION OF CONTRACT, TORT OR OTHERWISE, ARISING FROM, OUT OF OR IN CONNECTION WITH THE SOFTWARE OR THE USE OR OTHER DEALINGS IN THE SOFTWARE.

## ❑ getopt

<http://cvsweb.netbsd.org/bsdweb.cgi/src/lib/libc/stdlib/>

Copyright (c) 1987, 1993, 1994 The Regents of the University of California. All rights reserved.

Redistribution and use in source and binary forms, with or without modification, are permitted provided that the following conditions are met:

1. Redistributions of source code must retain the above copyright notice, this list of conditions and the following disclaimer.
2. Redistributions in binary form must reproduce the above copyright notice, this list of conditions and the following disclaimer in the documentation and/or other materials provided with the distribution.
3. Neither the name of the University nor the names of its contributors may be used to endorse or promote products derived from this software without specific prior written permission.

THIS SOFTWARE IS PROVIDED BY THE REGENTS AND CONTRIBUTORS "AS IS" AND ANY EXPRESS OR IMPLIED WARRANTIES, INCLUDING, BUT NOT LIMITED TO, THE IMPLIED WARRANTIES OF MERCHANTABILITY AND FITNESS FOR A PARTICULAR PURPOSE ARE DISCLAIMED. IN NO EVENT SHALL THE REGENTS OR CONTRIBUTORS BE LIABLE FOR ANY DIRECT, INDIRECT, INCIDENTAL, SPECIAL, EXEMPLARY, OR CONSEQUENTIAL DAMAGES (INCLUDING, BUT NOT LIMITED TO, PROCUREMENT OF SUBSTITUTE GOODS OR SERVICES; LOSS OF USE, DATA, OR PROFITS; OR BUSINESS INTERRUPTION) HOWEVER CAUSED AND ON ANY THEORY OF LIABILITY, WHETHER IN CONTRACT, STRICT LIABILITY, OR TORT (INCLUDING NEGLIGENCE OR OTHERWISE) ARISING IN ANY WAY OUT OF THE USE OF THIS SOFTWARE, EVEN IF ADVISED OF THE POSSIBILITY OF SUCH DAMAGE.

## ❑ jQuery

Copyright 2014 jQuery Foundation and other contributors

<http://jquery.com/>

Permission is hereby granted, free of charge, to any person obtaining a copy of this software and associated documentation files (the "Software"), to deal in the Software without restriction, including without limitation the rights to use, copy, modify, merge, publish, distribute, sublicense, and/or sell copies of the Software, and to permit persons to whom the Software is furnished to do so, subject to the following conditions:

The above copyright notice and this permission notice shall be included in all copies or substantial portions of the Software.

THE SOFTWARE IS PROVIDED "AS IS", WITHOUT WARRANTY OF ANY KIND, EXPRESS OR IMPLIED, INCLUDING BUT NOT LIMITED TO THE WARRANTIES OF MERCHANTABILITY, FITNESS FOR A PARTICULAR PURPOSE AND NONINFRINGEMENT. IN NO EVENT SHALL THE AUTHORS OR COPYRIGHT HOLDERS BE LIABLE FOR ANY CLAIM, DAMAGES OR OTHER LIABILITY, WHETHER IN AN ACTION OF CONTRACT, TORT OR OTHERWISE, ARISING FROM, OUT OF OR IN CONNECTION WITH THE SOFTWARE OR THE USE OR OTHER DEALINGS IN THE SOFTWARE.

## ❑ libpcap-1.4.0

License: BSD

Redistribution and use in source and binary forms, with or without modification, are permitted provided that the following conditions are met:

1. Redistributions of source code must retain the above copyright notice, this list of conditions and the following disclaimer.
2. Redistributions in binary form must reproduce the above copyright notice, this list of conditions and the following disclaimer in the documentation and/or other materials provided with the distribution.
3. The names of the authors may not be used to endorse or promote products derived from this software without specific prior written permission.

THIS SOFTWARE IS PROVIDED "AS IS" AND WITHOUT ANY EXPRESS OR IMPLIED WARRANTIES, INCLUDING, WITHOUT LIMITATION, THE IMPLIED WARRANTIES OF MERCHANTABILITY AND FITNESS FOR A PARTICULAR PURPOSE.

## ❑ libtar-1.2.11

Copyright (c) 1998-2003 University of Illinois Board of Trustees

Copyright (c) 1998-2003 Mark D. Roth

All rights reserved.

Developed by: Campus Information Technologies and Educational Services, University of Illinois at Urbana-Champaign

Permission is hereby granted, free of charge, to any person obtaining a copy of this software and associated documentation files (the "Software"), to deal with the Software without restriction, including without limitation the rights to use, copy, modify, merge, publish, distribute, sublicense, and/or sell copies of the Software, and to permit persons to whom the Software is furnished to do so, subject to the following conditions:

- \* Redistributions of source code must retain the above copyright notice, this list of conditions and the following disclaimers.
- \* Redistributions in binary form must reproduce the above copyright notice, this list of conditions and the following disclaimers in the documentation and/or other materials provided with the distribution.
- \* Neither the names of Campus Information Technologies and Educational Services, University of Illinois at Urbana-Champaign, nor the names of its contributors may be used to endorse or promote products derived from this Software without specific prior written permission.

THE SOFTWARE IS PROVIDED "AS IS", WITHOUT WARRANTY OF ANY KIND, EXPRESS OR IMPLIED, INCLUDING BUT NOT LIMITED TO THE WARRANTIES OF MERCHANTABILITY, FITNESS FOR A PARTICULAR PURPOSE AND NONINFRINGEMENT.

IN NO EVENT SHALL THE CONTRIBUTORS OR COPYRIGHT HOLDERS BE LIABLE FOR ANY CLAIM, DAMAGES OR OTHER LIABILITY, WHETHER IN AN ACTION OF CONTRACT, TORT OR OTHERWISE, ARISING FROM, OUT OF OR IN CONNECTION WITH THE SOFTWARE OR THE USE OR OTHER DEALINGS WITH THE SOFTWARE.



## ❑ mDNS 320.10.80

The majority of the source code in the mDNSResponder project is licensed under the terms of the Apache License, Version 2.0, available from:

<<http://www.apache.org/licenses/LICENSE-2.0>>

To accommodate license compatibility with the widest possible range of client code licenses, the shared library code, which is linked at runtime into the same address space as the client using it, is licensed under the terms of the “Three-Clause BSD License”.

The Linux Name Service Switch code, contributed by National ICT Australia Ltd (NICTA) is licensed under the terms of the NICTA Public Software Licence (which is substantially similar to the “Three-Clause BSD License”, with some additional language pertaining to Australian law).

## ❑ mongoose

<https://github.com/cesanta/mongoose/>

Copyright (c) 2004-2013 Sergey Lyubka

Permission is hereby granted, free of charge, to any person obtaining a copy of this software and associated documentation files (the “Software”), to deal in the Software without restriction, including without limitation the rights to use, copy, modify, merge, publish, distribute, sublicense, and/or sell copies of the Software, and to permit persons to whom the Software is furnished to do so, subject to the following conditions:

The above copyright notice and this permission notice shall be included in all copies or substantial portions of the Software.

THE SOFTWARE IS PROVIDED “AS IS”, WITHOUT WARRANTY OF ANY KIND, EXPRESS OR IMPLIED, INCLUDING BUT NOT LIMITED TO THE WARRANTIES OF MERCHANTABILITY, FITNESS FOR A PARTICULAR PURPOSE AND NONINFRINGEMENT. IN NO EVENT SHALL THE AUTHORS OR COPYRIGHT HOLDERS BE LIABLE FOR ANY CLAIM, DAMAGES OR OTHER LIABILITY, WHETHER IN AN ACTION OF CONTRACT, TORT OR OTHERWISE, ARISING FROM, OUT OF OR IN CONNECTION WITH THE SOFTWARE OR THE USE OR OTHER DEALINGS IN THE SOFTWARE.

## ❑ openssl-1.0.0d

Copyright (c) 1998-2011 The OpenSSL Project. All rights reserved.

Redistribution and use in source and binary forms, with or without modification, are permitted provided that the following conditions are met:

1. Redistributions of source code must retain the above copyright notice, this list of conditions and the following disclaimer.
2. Redistributions in binary form must reproduce the above copyright notice, this list of conditions and the following disclaimer in the documentation and/or other materials provided with the distribution.
3. All advertising materials mentioning features or use of this software must display the following acknowledgment:  
“This product includes software developed by the OpenSSL Project for use in the OpenSSL Toolkit. (<http://www.openssl.org/>)”
4. The names “OpenSSL Toolkit” and “OpenSSL Project” must not be used to endorse or promote products derived from this software without prior written permission. For written permission, please contact [openssl-core@openssl.org](mailto:openssl-core@openssl.org).
5. Products derived from this software may not be called “OpenSSL” nor may “OpenSSL” appear in their names without prior written permission of the OpenSSL Project.
6. Redistributions of any form whatsoever must retain the following acknowledgment:  
“This product includes software developed by the OpenSSL Project for use in the OpenSSL Toolkit (<http://www.openssl.org/>)”

THIS SOFTWARE IS PROVIDED BY THE OpenSSL PROJECT “AS IS” AND ANY EXPRESSED OR IMPLIED WARRANTIES, INCLUDING, BUT NOT LIMITED TO, THE IMPLIED WARRANTIES OF MERCHANTABILITY AND FITNESS FOR A PARTICULAR PURPOSE ARE DISCLAIMED. IN NO EVENT SHALL THE OpenSSL PROJECT OR ITS CONTRIBUTORS BE LIABLE FOR ANY DIRECT, INDIRECT, INCIDENTAL, SPECIAL, EXEMPLARY, OR CONSEQUENTIAL DAMAGES (INCLUDING, BUT NOT LIMITED TO, PROCUREMENT OF SUBSTITUTE GOODS OR SERVICES; LOSS OF USE, DATA, OR PROFITS; OR BUSINESS INTERRUPTION) HOWEVER CAUSED AND ON ANY THEORY OF LIABILITY, WHETHER IN CONTRACT, STRICT LIABILITY, OR TORT (INCLUDING NEGLIGENCE OR OTHERWISE) ARISING IN ANY WAY OUT OF THE USE OF THIS SOFTWARE, EVEN IF ADVISED OF THE POSSIBILITY OF SUCH DAMAGE.

This product includes cryptographic software written by Eric Young ([eay@cryptsoft.com](mailto:eay@cryptsoft.com)). This product includes software written by Tim Hudson ([tjh@cryptsoft.com](mailto:tjh@cryptsoft.com)).



## ❑ portmap-6.0

Copyright (c) 1990 The Regents of the University of California.

\* All rights reserved.

\* Redistribution and use in source and binary forms, with or without modification, are permitted provided that the following conditions are met:

1. Redistributions of source code must retain the above copyright notice, this list of conditions and the following disclaimer.
2. Redistributions in binary form must reproduce the above copyright notice, this list of conditions and the following disclaimer in the documentation and/or other materials provided with the distribution.
3. A ll advertising materials mentioning features or use of this software must display the following acknowledgement:  
This product includes software developed by the University of California, Berkeley and its contributors.
4. Neither the name of the University nor the names of its contributors may be used to endorse or promote products derived from this software without specific prior written permission.

\* THIS SOFTWARE IS PROVIDED BY THE REGENTS AND CONTRIBUTORS "AS IS" AND ANY EXPRESS OR IMPLIED WARRANTIES, INCLUDING, BUT NOT LIMITED TO, THE IMPLIED WARRANTIES OF MERCHANTABILITY AND FITNESS FOR A PARTICULAR PURPOSE ARE DISCLAIMED. IN NO EVENT SHALL THE REGENTS OR CONTRIBUTORS BE LIABLE FOR ANY DIRECT, INDIRECT, INCIDENTAL, SPECIAL, EXEMPLARY, OR CONSEQUENTIAL DAMAGES (INCLUDING, BUT NOT LIMITED TO, PROCUREMENT OF SUBSTITUTE GOODS OR SERVICES; LOSS OF USE, DATA, OR PROFITS; OR BUSINESS INTERRUPTION) HOWEVER CAUSED AND ON ANY THEORY OF LIABILITY, WHETHER IN CONTRACT, STRICT LIABILITY, OR TORT (INCLUDING NEGLIGENCE OR OTHERWISE) ARISING IN ANY WAY OUT OF THE USE OF THIS SOFTWARE, EVEN IF ADVISED OF THE POSSIBILITY OF SUCH DAMAGE.

## ❑ pstdint.h-0.1.12

\* BSD License:

\* Copyright (c) 2005-2011 Paul Hsieh

\* All rights reserved.

\* Redistribution and use in source and binary forms, with or without modification, are permitted provided that the following conditions are met:

1. Redistributions of source code must retain the above copyright notice, this list of conditions and the following disclaimer.
2. Redistributions in binary form must reproduce the above copyright notice, this list of conditions and the following disclaimer in the documentation and/or other materials provided with the distribution.
3. The name of the author may not be used to endorse or promote products derived from this software without specific prior written permission.

\* THIS SOFTWARE IS PROVIDED BY THE AUTHOR "AS IS" AND ANY EXPRESS OR IMPLIED WARRANTIES, INCLUDING, BUT NOT LIMITED TO, THE IMPLIED WARRANTIES OF MERCHANTABILITY AND FITNESS FOR A PARTICULAR PURPOSE ARE DISCLAIMED.

\* IN NO EVENT SHALL THE AUTHOR BE LIABLE FOR ANY DIRECT, INDIRECT, INCIDENTAL, SPECIAL, EXEMPLARY, OR CONSEQUENTIAL DAMAGES (INCLUDING, BUT NOT LIMITED TO, PROCUREMENT OF SUBSTITUTE GOODS OR SERVICES; LOSS OF USE, DATA, OR PROFITS; OR BUSINESS INTERRUPTION) HOWEVER CAUSED AND ON ANY THEORY OF LIABILITY, WHETHER IN CONTRACT, STRICT LIABILITY, OR TORT (INCLUDING NEGLIGENCE OR OTHERWISE) ARISING IN ANY WAY OUT OF THE USE OF THIS SOFTWARE, EVEN IF ADVISED OF THE POSSIBILITY OF SUCH DAMAGE.



### ❑ **rl78flash 2000.3.1**

License

=====

The MIT License (MIT)

Copyright (c) 2012 Maxim Salov

Permission is hereby granted, free of charge, to any person obtaining a copy of this software and associated documentation files (the "Software"), to deal in the Software without restriction, including without limitation the rights to use, copy, modify, merge, publish, distribute, sublicense, and/or sell copies of the Software, and to permit persons to whom the Software is furnished to do so, subject to the following conditions:

The above copyright notice and this permission notice shall be included in all copies or substantial portions of the Software.

THE SOFTWARE IS PROVIDED "AS IS", WITHOUT WARRANTY OF ANY KIND, EXPRESS OR IMPLIED, INCLUDING BUT NOT LIMITED TO THE WARRANTIES OF MERCHANTABILITY, FITNESS FOR A PARTICULAR PURPOSE AND NONINFRINGEMENT. IN NO EVENT SHALL THE AUTHORS OR COPYRIGHT HOLDERS BE LIABLE FOR ANY CLAIM, DAMAGES OR OTHER LIABILITY, WHETHER IN AN ACTION OF CONTRACT, TORT OR OTHERWISE, ARISING FROM, OUT OF OR IN CONNECTION WITH THE SOFTWARE OR THE USE OR OTHER DEALINGS IN THE SOFTWARE.

### ❑ **sqlite 2003.5.7**

SQLite Copyright

SQLite is in the  
Public Domain

All of the code and documentation in SQLite has been dedicated to the public domain by the authors. All code authors, and representatives of the companies they work for, have signed affidavits dedicating their contributions to the public domain and originals of those signed affidavits are stored in a firesafe at the main offices of Hwaci. Anyone is free to copy, modify, publish, use, compile, sell, or distribute the original SQLite code, either in source code form or as a compiled binary, for any purpose, commercial or non-commercial, and by any means.

The previous paragraph applies to the deliverable code and documentation in SQLite - those parts of the SQLite library that you actually bundle and ship with a larger application. Some scripts used as part of the build process (for example the "configure" scripts generated by autoconf) might fall under other open-source licenses. Nothing from these build scripts ever reaches the final deliverable SQLite library, however, and so the licenses associated with those scripts should not be a factor in assessing your rights to copy and use the SQLite library.

All of the deliverable code in SQLite has been written from scratch. No code has been taken from other projects or from the open internet. Every line of code can be traced back to its original author, and all of those authors have public domain dedications on file. So the SQLite code base is clean and is uncontaminated with licensed code from other projects.

## ❑ `strncpy.c` , v1.11

- \* Copyright (c) 1998 Todd C. Miller <Todd.Miller@courtesan.com>
- \* Permission to use, copy, modify, and distribute this software for any purpose with or without fee is hereby granted, provided that the above copyright notice and this permission notice appear in all copies.
- \* THE SOFTWARE IS PROVIDED “AS IS” AND THE AUTHOR DISCLAIMS ALL WARRANTIES WITH REGARD TO THIS SOFTWARE INCLUDING ALL IMPLIED WARRANTIES OF MERCHANTABILITY AND FITNESS. IN NO EVENT SHALL THE AUTHOR BE LIABLE FOR ANY SPECIAL, DIRECT, INDIRECT, OR CONSEQUENTIAL DAMAGES OR ANY DAMAGES WHATSOEVER RESULTING FROM LOSS OF USE, DATA OR PROFITS, WHETHER IN AN ACTION OF CONTRACT, NEGLIGENCE OR OTHER TORTIOUS ACTION, ARISING OUT OF OR IN CONNECTION WITH THE USE OR PERFORMANCE OF THIS SOFTWARE.

## ❑ `taglib-1.5`

copyright : (C) 2002 - 2008 by Scott Wheeler  
email : [wheeler@kde.org](mailto:wheeler@kde.org)

“The contents of this file are subject to the Mozilla Public License Version 1.1 (the “License”); you may not use this file except in compliance with the License. You may obtain a copy of the License at <http://www.mozilla.org/MPL/>

Software distributed under the License is distributed on an “AS IS” basis, WITHOUT WARRANTY OF ANY KIND, either express or implied. See the License for the specific language governing rights and limitations under the License.

## ❑ `tinycl 2002.4.3`

[www.sourceforge.net/projects/tinycl](http://www.sourceforge.net/projects/tinycl)

Original file by Yves Berquin.

This software is provided 'as-is', without any express or implied warranty. In no event will the authors be held liable for any damages arising from the use of this software.

Permission is granted to anyone to use this software for any purpose, including commercial applications, and to alter it and redistribute it freely, subject to the following restrictions:

1. The origin of this software must not be misrepresented; you must not claim that you wrote the original software. If you use this software in a product, an acknowledgment in the product documentation would be appreciated but is not required.
2. Altered source versions must be plainly marked as such, and must not be misrepresented as being the original software.
3. This notice may not be removed or altered from any source distribution.





## ❑ Tremor

<http://wiki.xiph.org/index.php/Tremor>

Copyright (c) 2002, Xiph.org Foundation

Redistribution and use in source and binary forms, with or without modification, are permitted provided that the following conditions are met:

1. Redistributions of source code must retain the above copyright notice, this list of conditions and the following disclaimer.
2. Redistributions in binary form must reproduce the above copyright notice, this list of conditions and the following disclaimer in the documentation and/or other materials provided with the distribution.
3. Neither the name of the Xiph.org Foundation nor the names of its contributors may be used to endorse or promote products derived from this software without specific prior written permission.

THIS SOFTWARE IS PROVIDED BY THE COPYRIGHT HOLDERS AND CONTRIBUTORS "AS IS" AND ANY EXPRESS OR IMPLIED WARRANTIES, INCLUDING, BUT NOT LIMITED TO, THE IMPLIED WARRANTIES OF MERCHANTABILITY AND FITNESS FOR A PARTICULAR PURPOSE ARE DISCLAIMED. IN NO EVENT SHALL THE FOUNDATION OR CONTRIBUTORS BE LIABLE FOR ANY DIRECT, INDIRECT, INCIDENTAL, SPECIAL, EXEMPLARY, OR CONSEQUENTIAL DAMAGES (INCLUDING, BUT NOT LIMITED TO, PROCUREMENT OF SUBSTITUTE GOODS OR SERVICES; LOSS OF USE, DATA, OR PROFITS; OR BUSINESS INTERRUPTION) HOWEVER CAUSED AND ON ANY THEORY OF LIABILITY, WHETHER IN CONTRACT, STRICT LIABILITY, OR TORT (INCLUDING NEGLIGENCE OR OTHERWISE) ARISING IN ANY WAY OUT OF THE USE OF THIS SOFTWARE, EVEN IF ADVISED OF THE POSSIBILITY OF SUCH DAMAGE.

## ❑ zlib

<http://www.zlib.net/>

zlib.h -- interface of the 'zlib' general purpose compression library version 1.2.3, July 18th, 2005

Copyright (C) 1995-2004 Jean-loup Gailly and Mark Adler

This software is provided 'as-is', without any express or implied warranty. In no event will the authors be held liable for any damages arising from the use of this software.

Permission is granted to anyone to use this software for any purpose, including commercial applications, and to alter it and redistribute it freely, subject to the following restrictions:

1. The origin of this software must not be misrepresented; you must not claim that you wrote the original software. If you use this software in a product, an acknowledgment in the product documentation would be appreciated but is not required.
2. Altered source versions must be plainly marked as such, and must not be misrepresented as being the original software.
3. This notice may not be removed or altered from any source distribution.

Jean-loup Gailly [jloup@gzip.org](mailto:jloup@gzip.org), Mark Adler  
[madler@alumni.caltech.edu](mailto:madler@alumni.caltech.edu)

- ❑ **The Spotify software is subject to third party licenses found here:**

[www.spotify.com/connect/third-party-licenses](http://www.spotify.com/connect/third-party-licenses)

**DENON®**

[HEOSbyDenon.com](http://HEOSbyDenon.com)

3520 10492 00AD

Copyright © 2017 D&M Holdings Inc. All Rights Reserved.